

Product Data

DeltaTron[®] Range

Miniature Accelerometer Types 4394, 4397
Accelerometer Types 4395, 4396, 4398, 4399
Charge Converter Type 2646
Power Supply ZG 0328

USES:

- Shock and vibration measurement
- Vibration analysis
- Vibration monitoring
- Vibration test control
- Product and quality control

- Charge converter for conventional accelerometers
- Adaptor for Brüel & Kjær analyzer inputs
- Accelerometers with:

- Integral preamplifiers
 - All-welded construction
 - Delta Shear[®] Uni-Gain design
 - Plain or Insulated base
 - Low sensitivity to all extraneous environments
 - Individual standard-traceable calibration

FEATURES:

- All DeltaTron[®] products operate on constant-current line-drive principles

DeltaTron[®] is the generic name for the new family of accelerometers and signal conditioning products from Brüel & Kjær. The DeltaTron[®] name identifies products that are designed to operate on a constant-current power supply and to give output signals in the form of voltage modulation on the power supply line.

The DeltaTron[®] range described in this Data Sheet comprises:

- Piezoelectric accelerometers with integral preamplifiers.
- Charge converter for use with conventional accelerometers.
- Power supply/adaptor for use with Brüel & Kjær Signal Analyzers and other instruments with 7-pin microphone inputs.

All DeltaTron[®] accelerometers are individually calibrated and a calibration chart showing the individually measured frequency response curve is provided with each accelerometer.

In addition to the products described in this Data Sheet, Brüel & Kjær also supply DeltaTron[®] accelerometers for permanent industrial installations, a comprehensive range of Delta Shear[®] piezoelectric accelerometers and a wide range of signal conditioning amplifiers. Details of these products are given in their respective Product Data sheets.



DeltaTron® Accelerometers

The DeltaTron® accelerometers described here are constructed to the proven Brüel & Kjær Delta Shear® design with the addition of an integral preamplifier. They require an external constant-current, power supply and operate as voltage sources.

DeltaTron® accelerometers operate over a frequency range from below 1 Hz to approximately half the resonance frequency of the accelerometer assembly. All are supplied with individual calibration charts which give individually measured frequency response curves (see Fig. 1).

Design and Construction

PZ 23 lead zirconate titanate, piezoelectric elements are used in the accelerometers, whose housings are all-welded. The accelerometers are available as types, with a plain base (no insulation), or as types with an insulated base.

On the insulated types the mounting bases are insulated by high-quality ceramic discs bonded between base and housing. Both base and housing are made of titanium, making the accelerometers very corrosion resistant.

The built-in preamplifier is a charge converter made using thick film technology. It comprises a low-noise MOS Field Effect Transistor as its input stage and a bipolar transistor to give low output impedance. A single-pole filter at the input extends the accelerometer's usable frequency range to approximately 50% of the mounted resonance frequency. Special efforts have been made to minimise interference from RF (radio frequency) electromagnetic fields.

Characteristics

Uni-Gain Sensitivity

The Brüel & Kjær Uni-Gain designation applies to all DeltaTron® accelerometers. This means that the accelerometer sensitivity is adjusted during manufacture to within 2% of either 1 or 10 mV/ms⁻².

Frequency response

The upper frequency limits given in the specifications are the frequencies where the deviation from the reference sensitivity is less than 10%. It is approximately 50% of the mounted resonance frequency. This assumes that the accelerometer is correctly mounted onto the test structure – a poor mounting can have a marked effect on the mounted resonance frequency.

The lower frequency limits and phase response are determined by the built-in preamplifiers. The lower frequency limits are given in the specifications for deviations from reference sensitivity of less than 10%.

The low damping of Brüel & Kjær accelerometers leads to the single, well-defined resonance peak shown on the frequency response curves.

The individually measured frequency response curves with absolute values of amplitude and phase are given on the calibration chart for the major part of the frequency range. At low and high frequencies, the curves given are typical (Fig. 1).

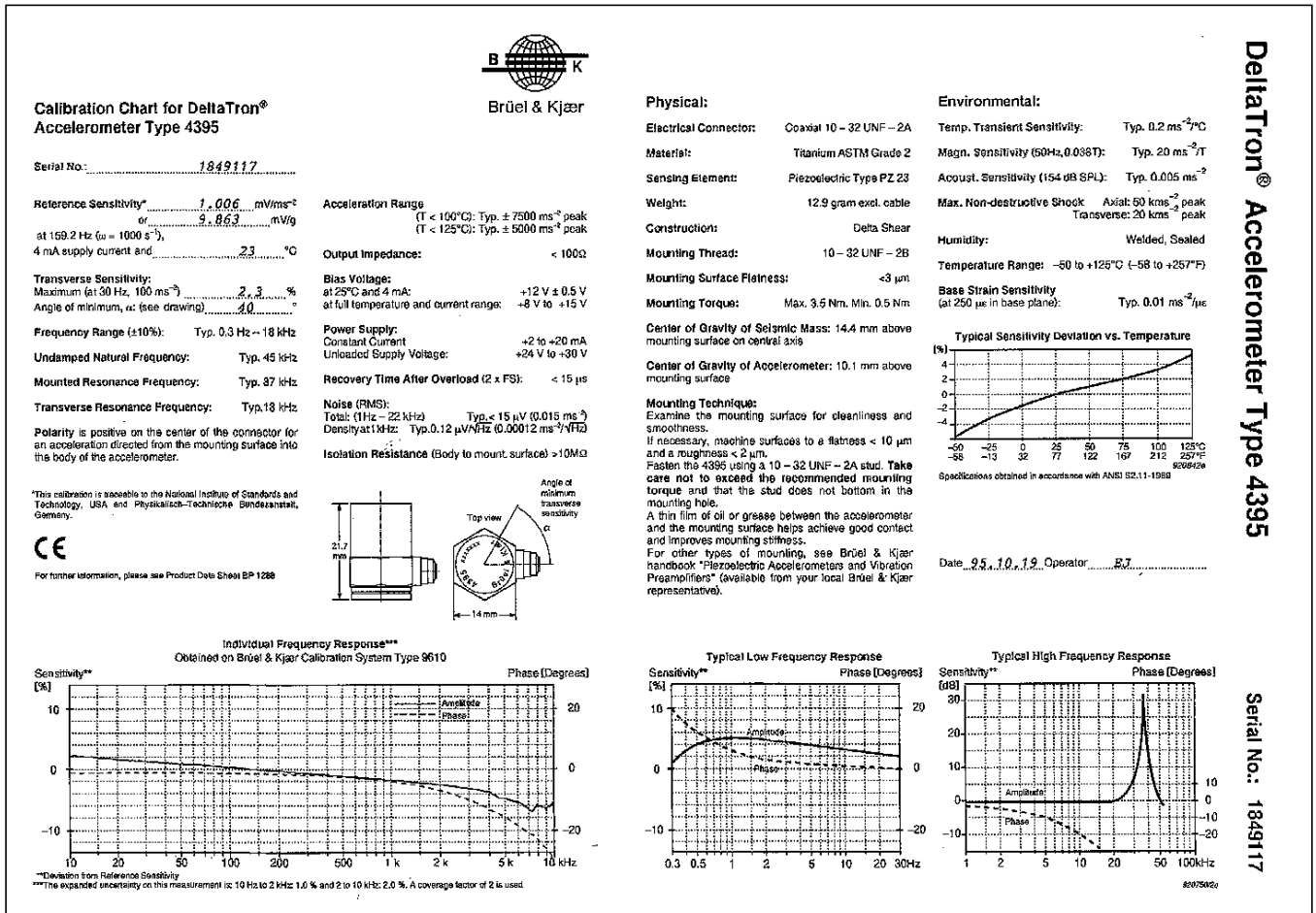

Fig. 1 Example of the calibration chart supplied with Brüel & Kjær DeltaTron® accelerometers

Transverse Sensitivity

All piezoelectric accelerometers are slightly sensitive to acceleration that is perpendicular to their main sensitivity axis. This transverse sensitivity is measured during the factory calibration process using a 30 Hz and 100 ms^{-2} excitation, and is given as a percentage of the corresponding main axis sensitivity.

The direction of minimum transverse sensitivity is indicated on the calibration chart of each DeltaTron[®] accelerometer.

Transverse Resonance Frequency

Typical values for the transverse resonance frequency are obtained by mounting an accelerometer on the side of a steel cube attached to a Calibration Exciter Type 4290.

Dynamic Range

The dynamic range of an accelerometer is the range over which its electrical output is directly proportional to the acceleration applied to its base.

Upper Limit

In general, the smaller the accelerometer, the higher the vibration level at which it can be used. The upper limit depends on the type of vibration to which the accelerometer is subjected and is determined by the pre-stressing of the piezoelectric elements as well as by the mechanical strength of the element.

The acceleration ranges given in the specifications are determined by the measuring limits of the integral preamplifiers. For transporting and handling, the maximum non-destructive shock is given.

When short duration transient signals are measured, care must be taken to avoid ringing effects due to the high-frequency resonance of the accelerometer. As a general rule, the duration of a half sine shock pulse should be greater than $5/f_r$ for an amplitude error of less than 10%, where f_r is the mounted resonance frequency of the accelerometer.

Lower Limit

The lower limit is imposed by the noise level of the integral preamplifier, which has been constructed to give very low noise levels, and by the environment in which the measurements are made.

A discussion of the effect of environmental influences, can be found in the Brüel & Kjær handbook "Piezoelectric Accelerometers and Vibration Preamplifiers".

Electrical Impedance

All DeltaTron[®] accelerometers have integral preamplifiers and can be regarded as voltage sources. The output impedance is specified as typically less than $100\ \Omega$. With a supply current of $>4\text{ mA}$ output impedance is typically $<30\ \Omega$.

Environment

Temperature

DeltaTron[®] accelerometers are specified to an operating temperature range of -50°C to $+125^\circ\text{C}$. Throughout this range, the sensitivity of the accelerometers has a small temperature dependence, details of this are given in the individual calibration charts (see Fig. 1).

Temperature Transients

All piezoelectric accelerometers have slight sensitivity to temperature fluctuations. This effect may be significant when low frequency, low level accelerations are being measured.

The procedure for measuring temperature transient sensitivity is described in the Brüel & Kjær handbook "Piezoelectric Accelerometers and Vibration Preamplifiers".

Humidity

DeltaTron[®] accelerometers have all-welded titanium housings to give them a high resistance to the majority of corrosive agents found in industry. The low impedance of the preamplifier gives it a low sensitivity to humidity on the output terminal and allows the accelerometers to be used without protection in conditions where there is small amounts of condensation.

Where heavy condensation is encountered, the use of moisture impervious cables and sealing will permit operation. Suitable sealants are Dow Corning RTV 738 or similar compounds.

Sound Pressure

The acoustic sensitivity is low, and for most vibration measurements it can be neglected. The vibration signal from the structure-under-test is normally much greater than the signal due to acoustic sensitivity.

Acoustic sensitivity is specified as an equivalent acceleration caused by a 154 dB sound pressure level in the frequency range 2 Hz to 100 Hz, but the specified value is normally valid outside this range.

Electromagnetic Compatibility (EMC)

Susceptibility of DeltaTron[®] accelerometers to radio-frequency electromagnetic radiation is also low.

The accelerometers are certified (CE) to Standards EN 50081-1 and EN 50082-2 for emission and immunity, respectively.

EN 50081-1 covers:

- Radiated emission from 30 to 1000 MHz
- Conducted emission from 0.15 to 30 MHz.

EN 50082-2 covers the effects of:

- Radio frequency fields from 20 to 1000 MHz at a field strength of 3 and 10 V/m with an amplitude modulation of 80%
- Electrostatic discharge at 4 and 8 kV
- Transient bursts at 1 kV
- Magnetic fields from 50 Hz to 20 kHz with a strength of 30 A/m at 50 Hz

Base Strains

These can be introduced into an accelerometer by distortion of the surface to which it is attached.

Base strain sensitivity, which is minimised by the Delta Shear[®] construction, is specified in $\text{ms}^{-2}/\mu\epsilon$.

Mounting

DeltaTron[®] accelerometers can be mounted with their main sensitivity axis aligned in any direction.

Recommended Mounting Technique

Fig. 2 shows the recommended mounting method for DeltaTron[®] accelerometers. Steel Stud YS 8321 is a flanged M3 stud which is used with Accelerometer Type 4394. It is available in sets of 25 as order number UA 1221. For the uninsulated miniature accelerometer Type 4397 steel stud YQ 2003 is used. For types 4395, 4396, 4398 and 4399, steel stud YQ 2962 is used. The accelerometers are screwed, using the stud, onto a clean metal surface meeting the requirements specified in Fig. 3. The optimum torque for tightening the M3 studs is between 0.2 Nm (1.8 lbf.-in) and 0.6 Nm (5.3 lbf.-in). For 10-32 UNF studs, the corresponding values are 0.5 Nm (4.4 lbf.-in) and 3.5 Nm (31 lbf.-in). To avoid possible damage to the ceramic disc, it is important that the maximum torque is not exceeded.

It should be noted when using the recommended technique, that if the

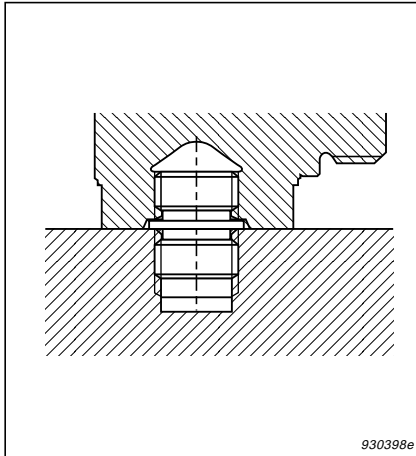

Fig. 2 Recommended mounting technique for Type 4394, using a steel stud YS 8321 (YQ 2003 for uninsulated base, Type 4397)

mounting surface is not perfectly smooth, the application of a thin layer of silicon grease to the base of the accelerometer before screwing it down on the mounting surface will improve the mounting stiffness.

Alternative Mounting Techniques

The section entitled Standard Accessories lists the mounting accessories that are supplied with individual accelerometers.

When mounting techniques other than the recommended one are used, the mounted resonance frequency of the accelerometer will probably be lowered. Most alternative mounting techniques are described in the Brüel & Kjær "Piezoelectric Accelerometers and Vibration Preamplifiers" handbook, where their effects on the frequency response are illustrated.

Connecting Cables

For direct connection to DeltaTron® accelerometers, miniature, double-screened low-noise, single-core, coaxial cables are available. These are a standard 1.2 m long, Teflon-insulated, cables that are supplied fitted with miniature coaxial plugs.

Types 4394 and 4397 require an M3 connector and is supplied with Cable AO 1381 which is fitted with one M3 and one 10–32 UNF connector. Types 4395, 4396, 4398 and 4399 are supplied with Cable AO 1382 which is fitted with two 10–32 UNF connectors. DeltaTron® Charge Converter Type 2646 is supplied without a cable, but AO 0406, a 5 m cable fitted with 10–32 UNF connectors and supplied with a 10–32 UNF to BNC adaptor, is available as an accessory. As an alternative, an AO 1382 cable

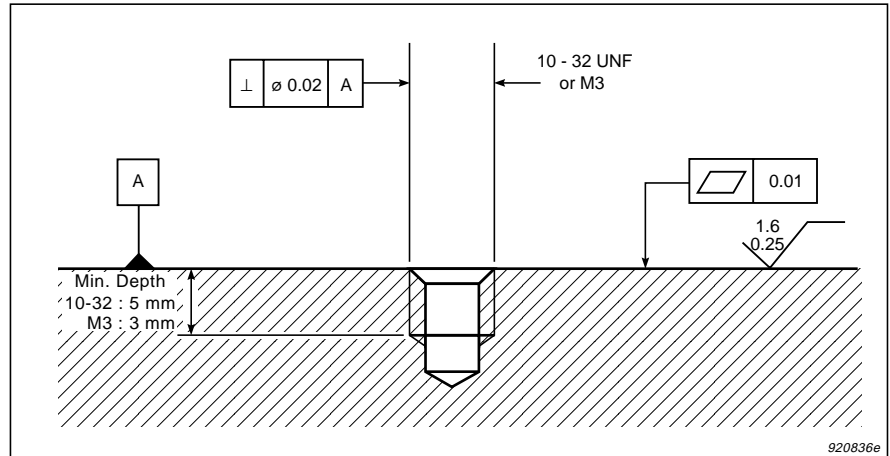

Fig. 3 Recommended tolerances for the mounting surfaces. Dimensions and symbols in accordance with ISO 1101

can be used. Additional cable lengths and connectors can be ordered.

Note, however, that for many, non-critical applications, lower quality cables or twisted pairs can be used. However, when such cables are used, the EMC certification is not valid.

Details of the accelerometer connections and recommended plug clearances are given in the section entitled Accelerometer Dimensions.

Maximum Cable Length

The maximum output voltage of a DeltaTron® accelerometer depends on the supply current at which it is operating, and on the capacitive load due to the connecting cable.

Fig. 4 shows typical curves for maximum output levels with supply currents of 2 and 20 mA (for distortion $\leq 1\%$). The maximum cable length in metres (L) is given by:

$$L = 75000 \times \frac{I_s}{f \times V_o \times C_m}$$

where:

I_s = supply current [mA]

f = frequency [kHz]

V_o = output voltage [V_{peak}]

C_m = cable capacitance [$\mu F/m$]

If the supply current is less than 4 mA, the power consumption of the built-in preamplifier becomes significant and this formula cannot be applied.

Calibration

Factory Calibration

All Brüel & Kjær Accelerometers are thoroughly checked and examined at each stage of manufacture and assembly. Every accelerometer under-

goes an extensive calibration procedure and artificial ageing process to ensure completely predictable performance and stable operation. Accurate numerical details of the calibration are reported on the calibration chart supplied with each transducer (see Fig. 1).

At Brüel & Kjær, piezoelectric accelerometers are calibrated by back-to-back comparison with a primary reference standard accelerometer which is regularly calibrated by laser interferometry at the Danish Primary Laboratory of Acoustics and by both the American National Institute of Standards and Technology and the German Physikalisch-Technische Bundesanstalt. The overall accuracy of the back-to-back comparison is 2% with a 99.9% confidence level (1.6% for a 99% confidence level), while for the interferometry method the accuracy is better than $\pm 0.6\%$ with a 99% confidence level.

Subsequent Calibration

Regular calibration of accelerometers helps maintain confidence in the measurements taken and indicates whether accelerometers have been damaged. Brüel & Kjær manufacture a range of equipment for frequency response, sensitivity and system calibrations, details of which are available in separate Product Data Sheets.

Individual Accelerometers

Dimensions and specifications for the accelerometers can be found in the schemes given towards the end of this Data Sheet.

**Miniature Accelerometer
Type 4394 and 4397**

These accelerometers are suitable for measurements on lightweight structures where relatively high-level, high-frequency vibrations are encountered.

**Shock and Vibration Accelerometer
Type 4395 and 4398**

Type 4395 and 4398 accelerometers are designed for the measurement of relatively high levels of continuous vibration and mechanical shock up to 7500 ms^{-2} .

**General Purpose Accelerometer
Type 4396 and 4399**

These accelerometers are intended to be used for general purpose vibration measurements.

**Charge Converter Type
2646**

Charge Converter Type 2646 is a signal conditioner designed for use with standard piezoelectric accelerometers or other piezoelectric transducers. It requires an external, constant-current power supply, and its function is to convert a charge input to a voltage-modulation of the constant-current power supply lines.

Type 2646 is also designed to withstand severe environments so that it can be mounted directly onto transducers with 10–32 UNF top connectors, or located in close proximity to transducers with side connectors.

For miniature size and low weight, Type 2646 has thick film electronics that are double sealed in a silicone elastomer compound and contained in a titanium housing. Type 2646 is supplied without a cable, however there is a space in the case for storing a cable. Cables AO 0406 and AO 1382 are available as accessories.

Full specifications are given on the last page of this Data Sheet, and the

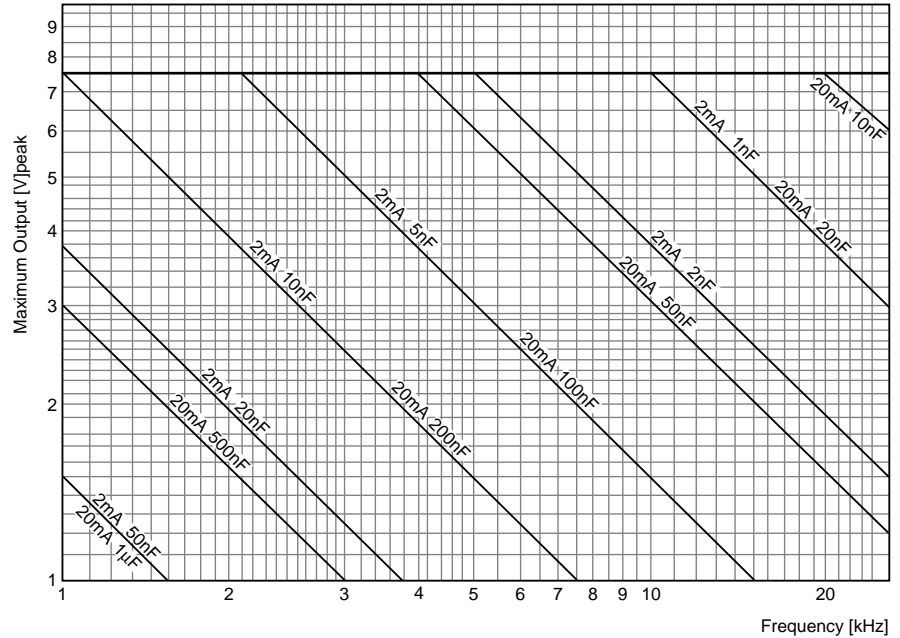

Fig.4 Typical curves for maximum output level of DeltaTron[®] accelerometers, showing maximum capacitive load over the recommended current supply range

extensive range of accelerometers that are suitable for use with Type 2646 are described in the Brüel & Kjær Data Sheet “Piezoelectric Accelerometers” (BP 0196).

**Power Supply Adaptor
ZG 0328**

The Power Supply Adaptor ZG 0328 is designed to connect directly into the 7-pin microphone (pre-amplifier) socket that is provided on many Brüel & Kjær instruments (except Types 2230 to 2235). The function of ZG 0328 is to adapt the socket for direct use with DeltaTron[®] accelerometers.

From the power available in the microphone socket, ZG 0328 provides the constant-current drive for the accelerometer and the signal input to the microphone socket.

**How to Order
Accelerometers**

Accelerometers are available as standard or as a **Set**.

As standard an accelerometer is supplied with a cable and mounting studs (for example Order No. **4395**).

An **Accelerometer Set** (suffix S after the type number) consists of a single accelerometer complete with cable and accessories in a case.

A complete list of the accessories supplied with each set or standard version, is given in the section on Standard Accessories. Additional accessories are available on separate order.

Accelerometer Dimensions Insulated Base

Shown full scale
All dimensions in mm

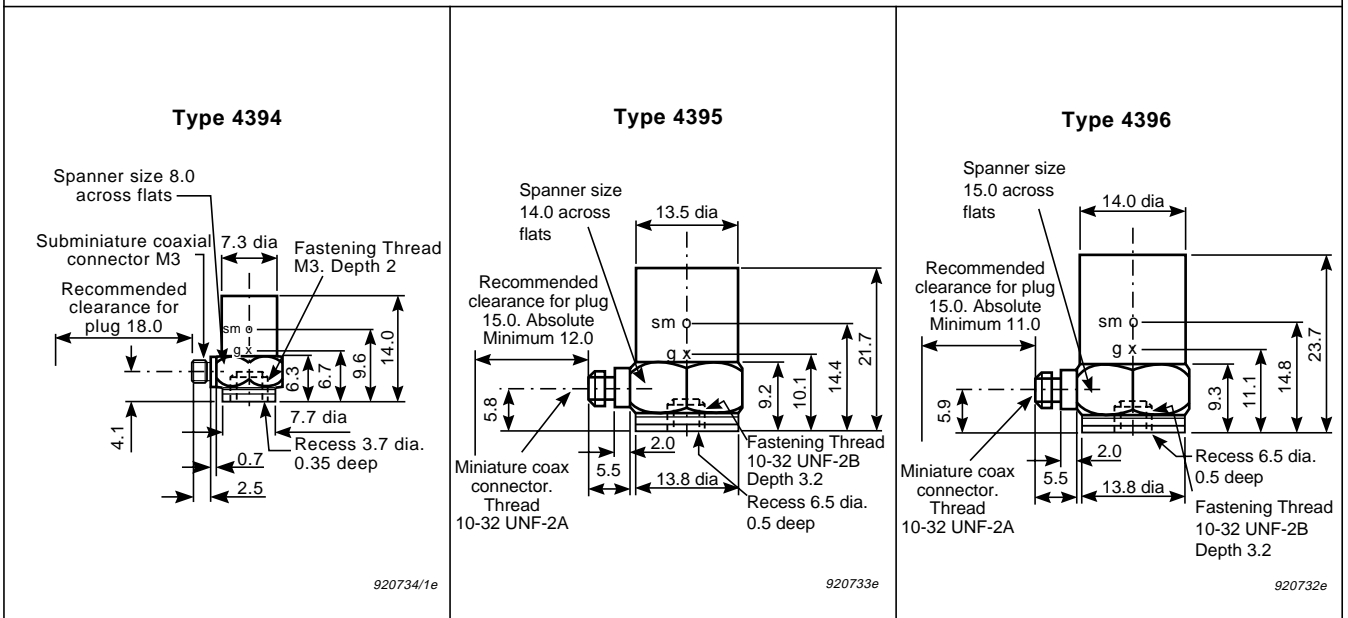

Accelerometer Dimensions Uninsulated Base

Shown full scale
All dimensions in mm

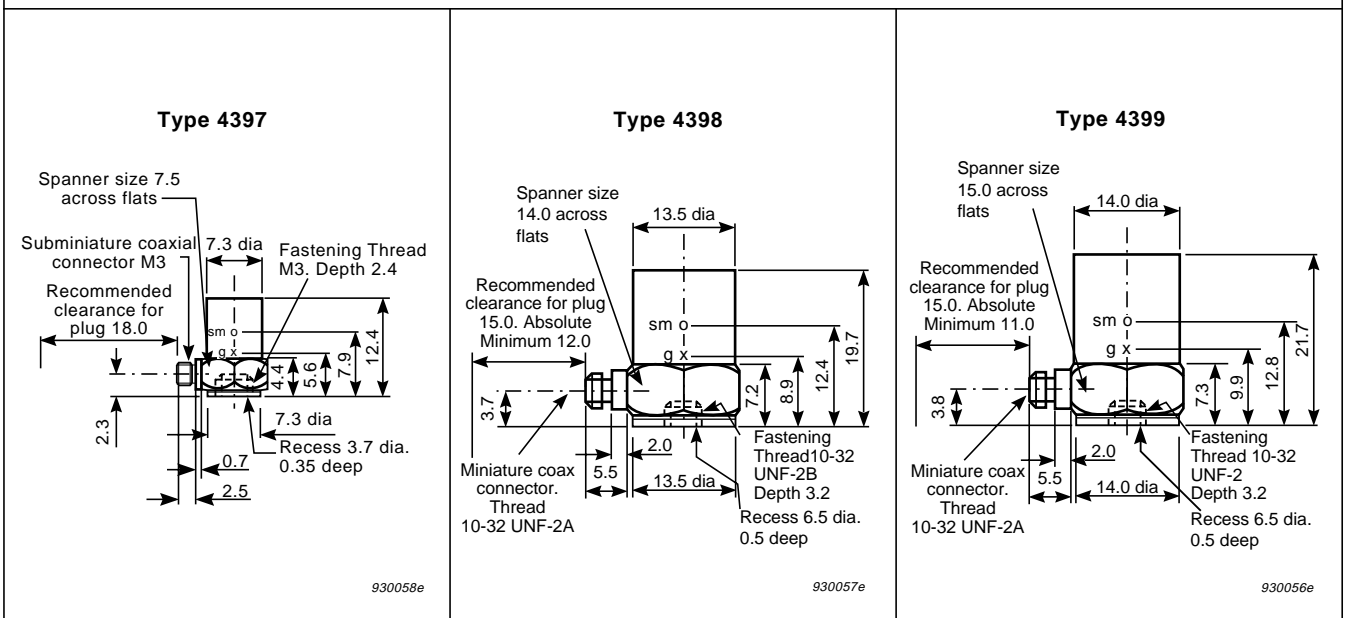

Standard Accessories

B&K Part Number	Standard Accessories	4394		4395		4396		4397		4398		4399	
		S		S		S		S		S		S	
AO 1381	Teflon low-noise cable, double screened AC0104 (∅ 1.6 mm). Fitted with one 10–32 UNF and one M3 connector. Length 1.2 m	1	1					1	1				
AO 1382	Teflon low-noise cable, double screened AC0104 (∅ 1.6 mm). Fitted with two 10–32 UNF connectors. Length 1.2 m			1	1	1	1			1	1	1	1
JJ0032	Extension connector for cables fitted with 10–32 UNF connectors	3		3		3		3		3		3	
JP 0145	10–32 UNF to BNC adaptor	1		1		1		1		1		1	
YS 8321	Steel stud M3/M3 (UA1221 is a set of 25 of these studs)	3	3										
YQ 2003	Steel Stud M3, 5 mm long							3	3				
YQ 2960	10–32 UNF threaded steel stud. Length 0.5 in.			2		2				2		2	
YQ 2962	10–32 UNF threaded steel stud. Length 0.3 in.			3	1	3	1			3	1	3	1
YM0414	10–32 UNF nut			1		1				1		1	
QA 0041	Tap for M3 thread	1						1					
QA 0029	Tap for 10–32 UNF thread			1		1				1		1	
DB 0757	Cement stud M3. Diameter 8 mm	1						1					
DB 0756	Cement stud 10–32 UNF. Diameter 14 mm			1		1				1		1	
QA 0042	Hexagonal key for M3 studs	1						1					
QA 0013	Hexagonal key for 10–32 UNF studs			1		1				1		1	
YJ 0216	Beeswax for mounting	1		1		1		1		1		1	
UA 0642	Mounting magnet with 10–32 UNF stud			1		1				1		1	
YO 0073	25 × adhesive mounting disc. Diameter 5.5 mm	1						1					
QS 0007	Tube of cyanoacrylate adhesive	1						1					
BC 0200	Individual calibration chart	1	1	1	1	1	1	1	1	1	1	1	1
	Accessory set included with S version		UA 1218		UA 1219		UA 1219		UA 1218		UA 1219		UA 1219

Table 1 The accelerometers can be ordered as standard version (for example: Order No. 4395) or as an “S” version (for example: Order No. 4395.S). This table gives details about which accessories are supplied with accelerometers in the standard version and which are supplied with the “S” version

Additional Accessories Available

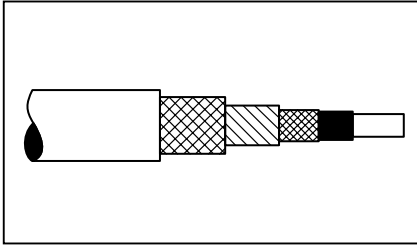

AC 0104. Teflon insulated double screened low-noise cable (illustrated).
AC 0005. Teflon insulated super low-noise cable.

AC 0200. Reinforced double screened version of AC 0005.

AC 0208. PVC coated cable
 The EMC certification (CE) is only valid for AC 0104.



AO 0406. Teflon insulated double screened cable AC 0104 fitted with 10-32 UNF connectors and supplied with a 10-32 UNF to BNC adaptor (JP 0145). Length 5 m.

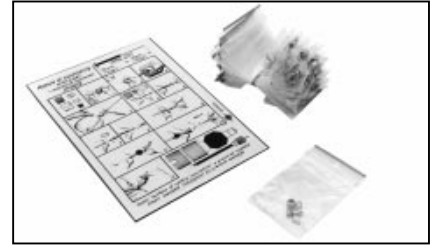

UA 0130. Set of 25 plugs JP 0012 for cable AC 0104 and AC 0005.

UA 0730. Set of 25 plugs JP 0056 for cable AC 0200. For mounting the plugs, the assembly tool QA 0035 is required.

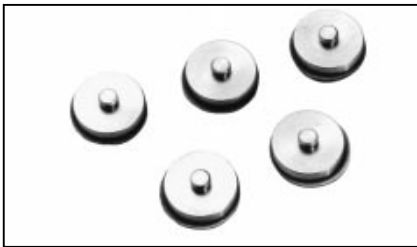

UA 0643. Set of 5 10-32 UNF mounting magnets UA 0642. Includes PTFE self adhesive discs for electrical insulation.

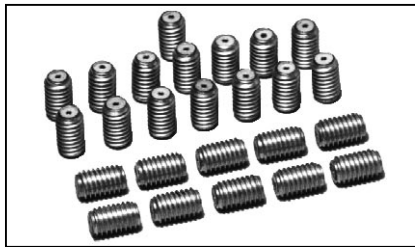

UA 0186. Set of 25 extension connectors JJ 0032 for miniature cables with plugs JP 0012 and JP 0056.



UA 0553. Set of 5 electrically insulated Mechanical Filters UA 0559, plus a tommy bar for mounting.



JP 0145. 10-32 UNF to BNC adaptor for connection of cables with miniature coaxial plugs JP 0012 and JP 0056.



QA 0035. Assembly tool for mounting miniature plugs on accelerometer cables.

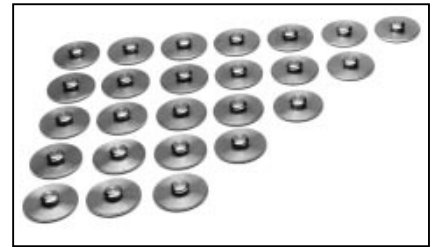

UA 0866. Set of 25 10-32 UNF cement studs DB 0756.

UA 0867. Set of 25 M3 cement studs DB 0757.





UA 1221. Set of 25 steel studs YS 8321.



UA 0125. Set of 10 insulating studs YP 0150, 10 steel studs YQ 2960, 10 nuts YM 0414, 10 mica washers YO 0534 plus 10-32 UNF tap and hexagonal key for 10-32 UNF studs.

Accelerometer Specifications Insulated Base

				
Type 4394	Type 4395	Type 4396		
Mounted Resonance Frequency, typical	kHz	52	37	28
Transverse Resonance Frequency, typical	kHz	15	13	9

Dynamic

Mounted Resonance Frequency, typical	kHz	52	37	28
Transverse Resonance Frequency, typical	kHz	15	13	9

Electrical

Case Insulation to Ground	MΩ	> 10		
---------------------------	----	------	--	--



Environmental

Base Strain Sensitivity, typical	ms ⁻² (g)/με	0.005 (0.0005)	0.01 (0.001)	0.005 (0.0005)
----------------------------------	-------------------------	----------------	--------------	----------------

Physical

Weight	gram (oz)	2.9 (0.10)	12.9 (0.46)	18.2 (0.64)
Height	mm (in)	14.0 (0.55)	21.7 (0.85)	23.7 (0.93)
Spanner Size	mm (in)	8.0 (0.31)	14.0 (0.55)	15.0 (0.59)

Accelerometer Specifications Uninsulated Base

				
Type 4397	Type 4398	Type 4399		
Mounted Resonance Frequency, typical	kHz	53	38	29
Transverse Resonance Frequency, typical	kHz	17	14	10

Dynamic

Mounted Resonance Frequency, typical	kHz	53	38	29
Transverse Resonance Frequency, typical	kHz	17	14	10

Environmental

Base Strain Sensitivity, typical	ms ⁻² (g)/με	0.005 (0.0005)	0.02 (0.002)	0.01 (0.001)
----------------------------------	-------------------------	----------------	--------------	--------------

Physical

Weight	gram (oz.)	2.4 (0.09)	11.8 (0.42)	17.1 (0.60)
Height	mm (in)	12.4 (0.49)	19.7 (0.77)	21.7 (0.85)
Spanner Size	mm (in)	7.5 (0.30)	14.0 (0.55)	15.0 (0.59)

Common Specifications for Both Types of Accelerometers

Dynamic		Type 4394 Type 4397	Type 4395 Type 4398	Type 4396 Type 4399
Sensitivity (axial) at 159.2Hz, 100 ms ⁻² (10.2g), 25°C (77°F), 4 mA mV/ms ⁻² (g)		1.00 (9.807) ± 2%		10.0 (98.07) ± 2%
Measuring Range (peak), typical	temperature <100°C (212°F)	±7500 (765)		±750 (76)
	temperature <125°C (257°F)	±5000 (510)		±500 (51)
Frequency Range (±10%), typical.*		1 to 25000	0.3 to 18000	1 to 14000
Maximum Transverse Response		%		
		< 4		

*Note: The frequency range from 10Hz to 10kHz is measured individually and shown on the calibration chart supplied. The expanded uncertainty on this measurement is: 1.0% from 10Hz to 2kHz and 2.0% from 2kHz to 10kHz at 2σ (i.e. expanded uncertainty using a coverage factor of 2)

Common Specifications for Both Types of Accelerometers (Cont.)

Electrical

Constant Current Supply	temperature <100°C (212°F)	mA	+2 to +20		
	temperature <125°C (257°F)	mA	+2 to +10	+2 to +20	
Supply Voltage, unloaded	for full specification	V DC	+24 to +30		
	minimum (reduced specification)	V DC	+18		
Output Impedance		Ω	<100		
Bias Voltage	at 25°C (77°F), 4 mA	V	12 ±0.5		
	full temperature and current range	V	8 to 15		
Residual Noise, typical	from 1 to 22000Hz	μV	<25	<15	<40
	equivalent acceleration	ms ⁻² (g)	<0.025 (0.0026)	<0.015 (0.0015)	<0.004 (0.0004)
Polarity (acceleration directed from base into body)			Positive		
Recovery time from Overload (2×maximum level)		μs	<20	<15	<25

Environmental

Maximum Non-destructive Shock (peak)	Axial	ms ⁻² (g)	100000 (10200)	50000 (5100)	20000 (2040)
	Transverse	ms ⁻² (g)	50000 (5100)	20000 (2040)	10000 (1020)
Temperature Range		°C (°F)	-50 to +125 (-58 to +257)		
Humidity			Welded, sealed		
Temperature Transient Sensitivity, typical		ms ⁻² /°C (g/°F)	2 (0.1)	0.2 (0.01)	0.1 (0.006)
Magnetic Sensitivity (50 Hz, 0.038T), typical		ms ⁻² (g)/T	10 (1)	20 (2)	5 (0.5)
Acoustic Sensitivity (154 dB SPL), typical		ms ⁻² (g)	0.01 (0.001)	0.005 (0.0005)	0.002 (0.0002)

Physical

Construction		Delta Shear			
Piezoelectric Material		PZ23			
Case Material	Titanium	ASTM Gr. 2			
Connector	Coaxial	M3 miniature	10–32 UNF		
Mounting Thread	Tapped center-hole	M3	10–32 UNF		
Mounting Torque	Nm (lb.in)	0.2 to 0.6 (1.8 to 5.3)	0.5 to 3.5 (4.4 to 31)		

Compliance with Standards

	CE-mark indicates compliance with: EMC Directive
Safety	EN 61010–1 and IEC 1010–1: Safety requirements for electrical equipment for measurement, control and laboratory use.
EMC Emission	EN 50081–1: Generic emission standard. Part 1: Residential, commercial and light industry. EN 50081–2: Generic emission standard. Part 2: Industrial environment. CISPR 22: Radio disturbance characteristics of information technology equipment. Class B Limits. FCC Class B limits
EMC Immunity	EN 50082–1: Generic immunity standard. Part 1: Residential, commercial and light industry. EN 50082–2: Generic immunity standard. Part 2: Industrial environment. Note: The above is guaranteed using accessories listed in this Product Data sheet only.
Temperature	IEC 68–2–1 & IEC 68–2–2: Environmental Testing. Cold and Dry Heat. Operating Temperature: –50 to +125°C (–58 to +257°F)
Humidity	IEC 68–2–3: 90% RH (non-condensing at 40°C (104°F))

Specifications for DeltaTron[®] Charge Converter Type 2646



Charge Input

INPUT CONNECTOR:

10–32 UNF coaxial. Used for direct attachment of 2646 to an accelerometer that has a top mounted connector. Also accepts a miniature accelerometer cable for side-by-side mounting with an accelerometer

MAXIMUM SINUSOIDAL INPUT:

7.5×10^3 pC peak at temperatures between –50 and +100°C (–58 and +212°F), decreasing to 5×10^3 pC at +125°C (257°F)

INPUT CAPACITANCE: >200 nF

Amplifier Response

SENSITIVITY:

1 mV/pC $\pm 1\%$ at 25°C (77°F) with a constant current of 4 mA

FREQUENCY RANGE:

0.3 Hz to 100 kHz (–10% limits)

NOISE RMS (referred to input terminated with a transducer capacitance of 1 nF):

Inherent, lin. 1 Hz to 22 kHz: $< 15 \times 10^{-3}$ pC

Density at 10 Hz: 0.80×10^{-3} pC/ $\sqrt{\text{Hz}}$

100 Hz: 0.28×10^{-3} pC/ $\sqrt{\text{Hz}}$

1 kHz: 0.12×10^{-3} pC/ $\sqrt{\text{Hz}}$

10 kHz: 0.05×10^{-3} pC/ $\sqrt{\text{Hz}}$

Electromagnetic: 5 pC/T (50 Hz, 0.038 T)

RECOVERY TIME ($2 \times \text{FS}$): <15 μs

Output

OUTPUT CONNECTOR:

10–32 UNF coaxial. Used for both signal output and power input through a single coaxial cable

PHASE (output referred to input): Inverted

OUTPUT IMPEDANCE: <100 Ω

Power Supply

CONSTANT CURRENT: +2 to +20 mA

UNLOADED SUPPLY VOLTAGE:

+24 to +30 V (minimum: +18 V with reduced specification)

BIAS VOLTAGE:

+12 ± 0.5 V at 4 mA and 25°C. For full temperature and current range, the bias voltage range is +8 to +15 V

Environmental

TEMPERATURE RANGE:

–50 to +125°C (–58 to +257°F). Sensitivity temperature coefficient is within $\pm 0.03\%/^{\circ}\text{C}$ ($\pm 0.016\%/^{\circ}\text{F}$)

HUMIDITY:

0 to 90% RH (non-condensing) without extra sealing

VIBRATION INDUCED NOISE:

1×10^{-3} pC/ ms^{-2} (0.01 pC/g)

MAXIMUM PHYSICAL SHOCK:

50 kms^{-2} (5100 g) peak

MAXIMUM INPUT WITHOUT DAMAGE:

50000 pC

CASE MATERIAL: Titanium ASTM Gr. 2

Dimensions and Weight

Diameter: 13.5 mm (0.53 in)

Height: 16.0 mm (0.64 in)

Weight: 5.3 g (0.19 oz.)

Note: All values are typical at 25°C (77°F), unless measurement uncertainty is specified

COMPLIANCE WITH STANDARDS:

CE	CE-mark indicates compliance with: EMC Directive.
Safety	EN 61010–1 and IEC 1010: Safety requirements for electrical equipment for measurement, control and laboratory use.
EMC Emission	EN 50081–1: Generic emission standard. Part 1: Residential, commercial and light industry. EN 50081–2: Generic emission standard. Part 2: Industrial environment. CISPR 22: Radio disturbance characteristics of information technology equipment. Class B Limits. FCC Rules, Part 15: Class B limits.
EMC Immunity	EN 50082–1: Generic immunity standard. Part 1: Residential, commercial and light industry. EN 50082–2: Generic immunity standard. Part 2: Industrial environment. Note 1: The above is guaranteed using accessories listed in this Product Data sheet only. Note 2: Sensitivity to RF common-mode, injected to signal line (in accordance with EN 50082–2): <70 μV (13 dB), with the converter connected directly to the accelerometer <900 μV (35 dB), with a cable between the converter and the accelerometer
Temperature	IEC 68–2–1 & IEC 68–2–2: Environmental Testing. Cold and Dry Heat. Operating Temperature: –50 to +125°C (–58 to +257°F)
Humidity	IEC 68–2–3: Damp Heat: 90% RH (non-condensing at 40°C (104°F))

Ordering Information

Type 2646 DeltaTron[®] Charge Converter
Includes the following accessories:
 JJ 0032: Cable Extension Connector (10–32 UNF)
 2 \times YJ 0606: O–Ring

Specifications for DeltaTron® Power Supply ZG0328



SHORT-CIRCUIT CURRENT: 3 ± 0.9 mA
UNLOADED SUPPLY VOLTAGE: 27 V
DYNAMIC IMPEDANCE: > 100 k Ω
NOISE RMS (inherent, Lin. 1 Hz to 22 kHz):
 < 50 nA
OUTPUT:
 Transducer signal connected to pin 4 of the microphone socket
TRANSDUCER CONNECTOR: BNC
SUPPLY CONNECTOR:
 Standard Brüel & Kjær 7-pin microphone plug

Environmental

TEMPERATURE RANGE:
 -10 to $+55^{\circ}\text{C}$ ($+14$ to $+131^{\circ}\text{F}$)
HUMIDITY: 0 to 90% RH (non-condensing)
CASE MATERIAL: Nickel-coated Brass

Dimensions and Weight

Diameter: 26.5 mm (1.04 in.)
Length: 52.5 mm (2.07 in.)
Weight: 48.5 g (1.707 oz.)

Note: All values are typical at 25°C (77°F), unless measurement uncertainty is specified.

COMPLIANCE WITH STANDARDS:

CE	CE-mark indicates compliance with: EMC Directive.
Safety	EN 61010-1 and IEC 1010-1: Safety requirements for electrical equipment for measurement, control and laboratory use.
EMC Emission	EN 50081-1: Generic emission standard. Part 1: Residential, commercial and light industry. EN 50081-2: Generic emission standard. Part 2: Industrial environment. CISPR 22: Radio disturbance characteristics of information technology equipment. Class B Limits. FCC Rules, Part 15: Class B limits.
EMC Immunity	EN 50082-1: Generic immunity standard. Part 1: Residential, commercial and light industry. EN 50082-2: Generic immunity standard. Part 2: Industrial environment. Note 1: The above is guaranteed using accessories listed in this Product Data sheet only. Note 2: Sensitivity to magnetic fields (30 A/m, 50 Hz): 80 nA
Temperature	IEC 68-2-1 & IEC 68-2-2: Environmental Testing. Cold and Dry Heat. Operating Temperature: -10 to $+55^{\circ}\text{C}$ ($+14$ to $+131^{\circ}\text{F}$) Storage Temperature: -25 to $+70^{\circ}\text{C}$ ($+13$ to $+158^{\circ}\text{F}$)
Humidity	IEC 68-2-3: Damp Heat: 90% RH (non-condensing at 40°C (104°F))
Mechanical	Non-operating IEC 68-2-6: Vibration: 0.3 mm, 20 m/s ² , 10–500 Hz IEC 68-2-27: Shock: 1000 m/s ² IEC 68-2-29: Bump: 4000 bumps at 400 m/s ²

Ordering Information

ZG 0328 DeltaTron® Power Supply
Includes the following accessories:
 JP 0145: 10–32 UNF to BNC adaptor

Brüel & Kjær reserves the right to change specifications and accessories without notice